

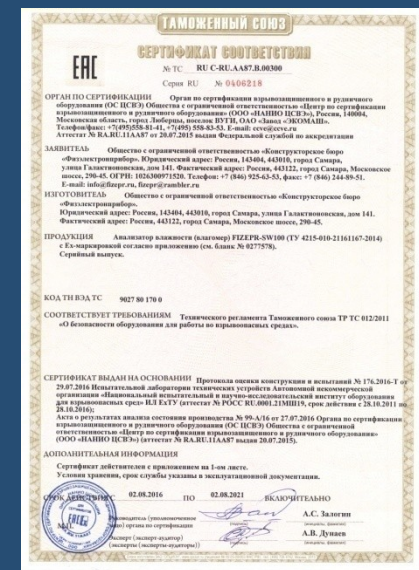

**Design Bureau FIZELEKTRONPRIBOR**

# Moisture analyzers (moisture meters) FIZEPR-SW100

for liquid, paste-like and bulk materials including petroleum, fuel oil, sand, coal, ore, concrete mixture, etc.



141, Galaktionovskaya str., 443010, Samara, Russia  
Phone: +7 (846) 925-63-53, 244-89-51, 952-83-82.  
E-mail: [info@fizepr.ru](mailto:info@fizepr.ru) , [fizepr@rambler.ru](mailto:fizepr@rambler.ru)

# FIZEPR-SW100 moisture meter versions

(differ by sensor design only)

## Probe version for bulk and liquid materials

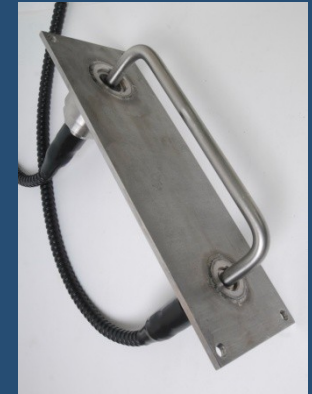
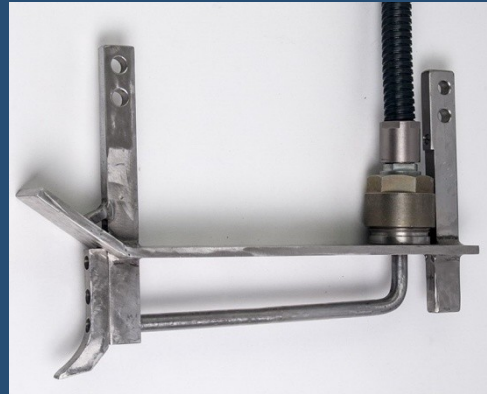

## In-line version



## Laboratory version



## For concrete mixers



## In-line moisture meters for liquid materials FIZEPR-SW100.20.x

The FIZEPR-SW100.20.x version moisture meters are designed for in-flow measurements of moisture in liquid materials, such as fuel oil, petroleum, alcohol, oils, etc.

The FIZEPR-SW100.20.x version moisture meters are made as a pipe section with two flanges of stainless steel AISI 316 or AISI 316Ti.

There is a probe inside the pipe made as a flat-topped stick of stainless steel of the same grade.

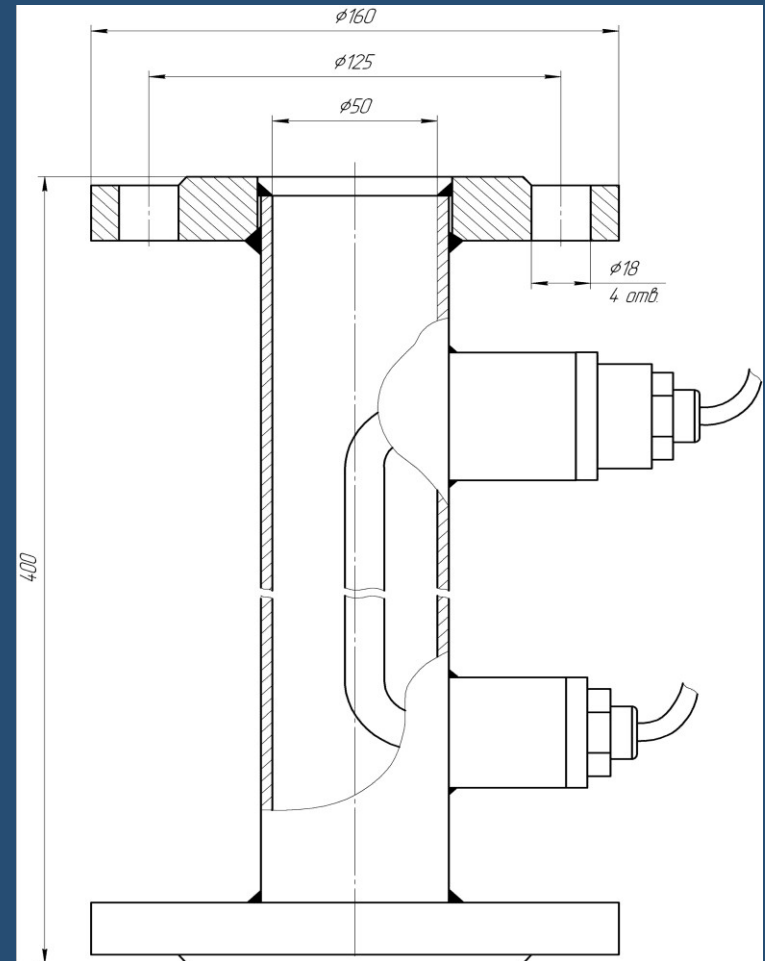

FIZEPR-SW100.20.5 sensor drawing  
DN50, PN25

## Features of FIZEPR-SW100.2x in-line moisture meters for liquid materials

- 1). The moisture meters are available in two versions with different nominal bore: DN50, DN65, DN80, DN100, DN125 and DN150.
- 2). Flange design corresponds to the required operating pressure and can be selected in the range up to 200 bar from the next array: PN16; PN25; PN40; PN63; PN100; PN160 and PN200.
- 3). The instruments are made in explosion-proof version. Sensor explosion proofing level: 0ExiaIIBT5.
- 4). Sensor design versions:

- 20 - straight-flow;
- 21 - full-flow;
- 22 - U-type;
- 24 - L-type;
- 25 - Z-type;
- 23 - straight-flow, for extreme temperatures and pressures





## Advantages of FIZEPR-SW100.2x sensors

- **not affected by fouling** (passage is almost empty) that is extremely important for using on fuel oil and other highly-viscous materials as well as on sludge and clay slurry in cement production
- **resistant to abrasive** materials
- **resistant** to mechanical stresses and impacts
- non-corrosive
- range of operating temperatures – up to **+145°C**, and optionally up to **+320°C**
- can be operated under **hard radiation conditions** since its electronics are located outside the hazardous area

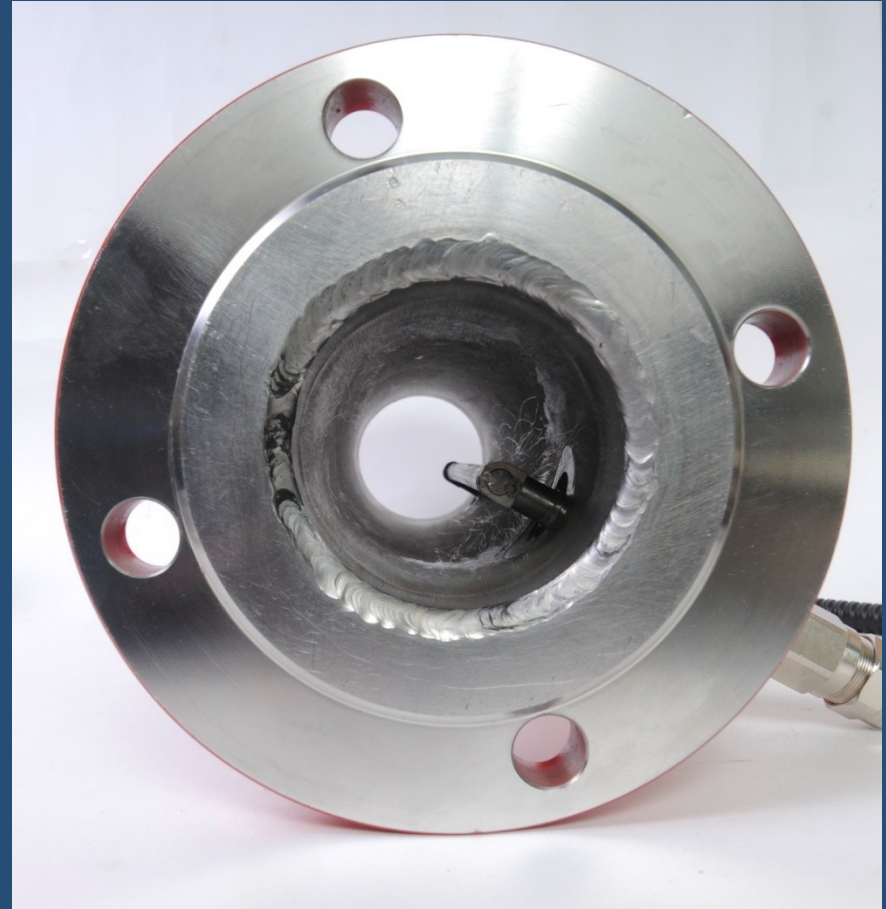

FIZEPR-SW100.20.6 sensor  
DN80, PN16

## Probe moisture meter for liquid materials FIZEPR-SW100.12

The FIZEPR-SW100.12 version moisture meters is easy to install in tanks filled with liquids: **petroleum**, fuel oil, **cement production sludge**

The sensor consists of a central rod probe and 4 shield rods. This design makes the sensor insensitive to the distance to tank walls and high measurement accuracy

This moisture meter can be used for process flow monitoring in oil treatment plants (OTP)



FIZEPR-SW100.12 sensor

## In-line moisture meter FIZEPR-SW100.21

It is designed to monitor liquid materials in pipelines with nominal bore (DN) of 150 mm and operating pressure up to 160 bar.

The sensor is installed on a pipeline using a nozzle welded on the side with a corresponding flange.

The sensor consists of a central rod probe and 4 shield rods mounted on the DN100 or DN65 flange.



FIZEPR-SW100.21.01 sensor

# Operating principle of FIZEPR-SW100

Like all dielectric moisture meters, the FIZEPR-SW100 determines material moisture using its permittivity  $\epsilon_r$ .

Each type of material has its own correlation between water content  $W$  and  $\epsilon_r$ .

Below there is a curve of diesel oil emulsion  $\epsilon_r$  dependence on its moisture content  $W$ . The measurements were made by the FIZEPR-SW100 moisture meter

Fuel oil  
M-100,  
 $t=20^\circ\text{C}$

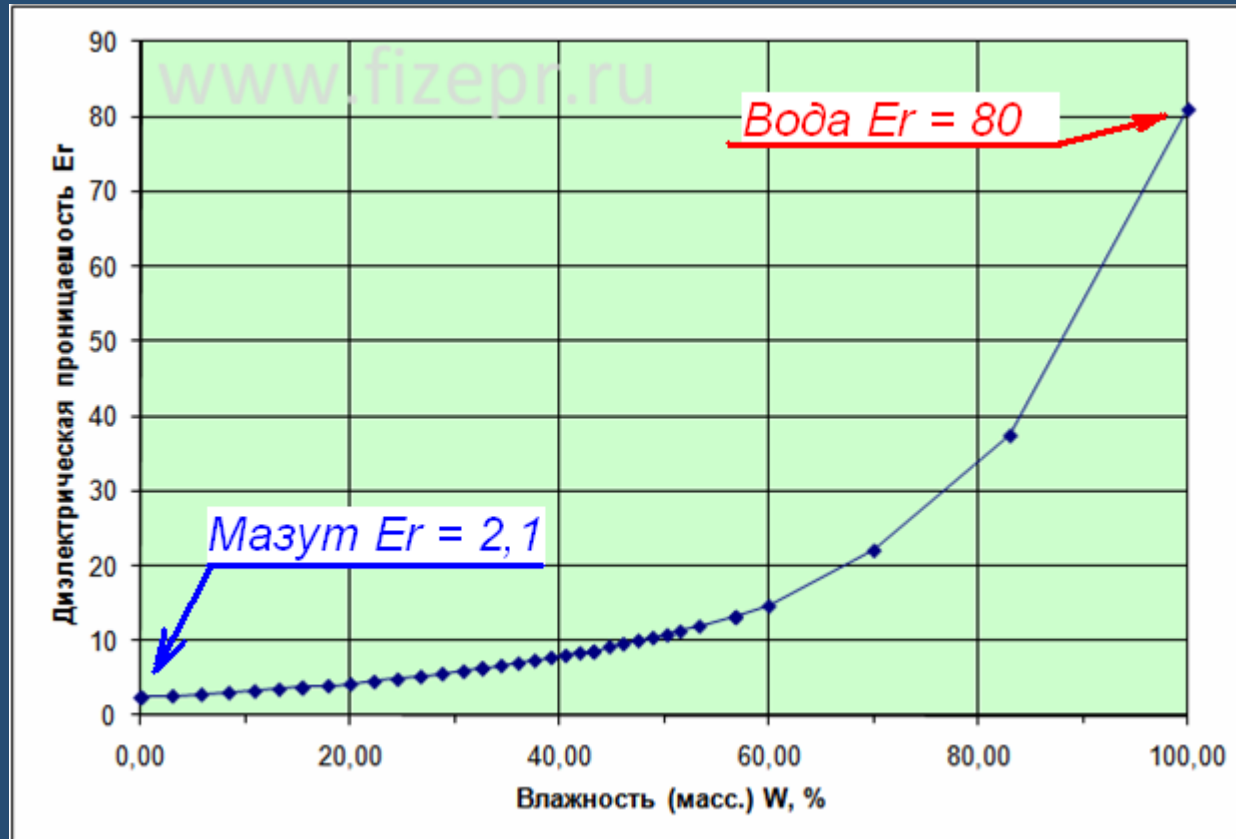



There are two methods of  $\epsilon_r$  permittivity measurements:

- by measuring the condenser structure capacity (capacitance moisture meters);
- by measuring the phase velocity or length of an electromagnetic wave propagated in a controlled environment (radiowave moisture meters).

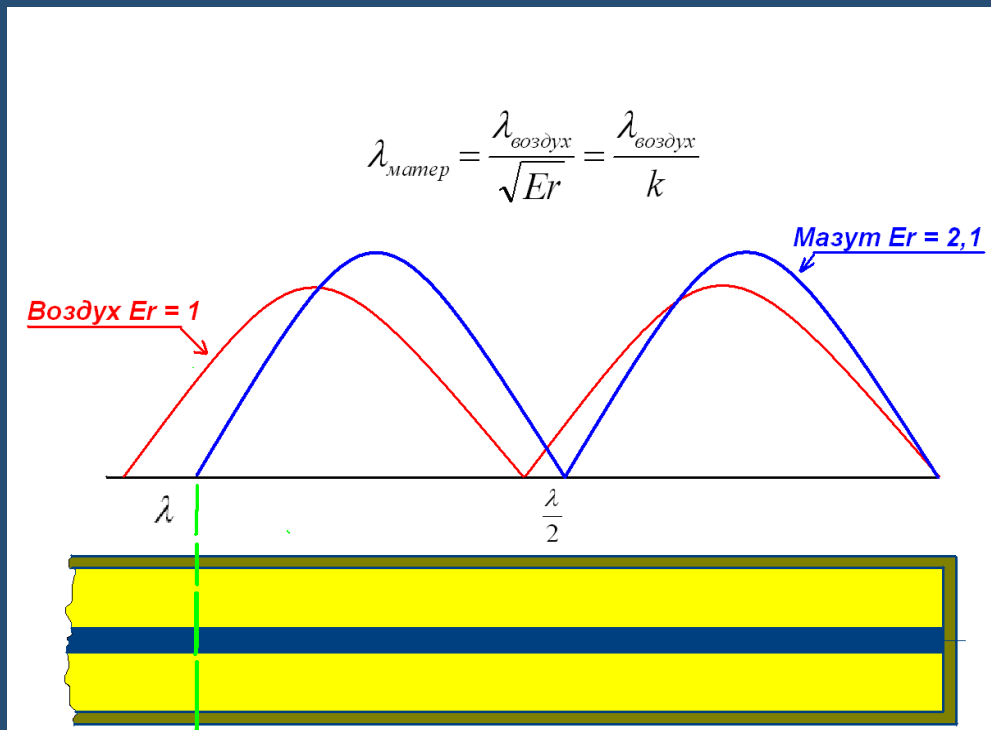

The figure shows distribution of electromagnetic wave voltage along the moisture meter probe length. Two characteristics are shown for two different values of  $\epsilon_r$  permittivity.

The FIZEPR-SW100 moisture meter uses a radiowave method of measurement: the instrument measures the parameters of an electromagnetic wave propagating in the material by measuring resonant frequency, i.e. frequency at which the defined number of half waves are laid on the probe length. Since the probe length is known, then the instrument determines the  $\epsilon_r$  value with a high accuracy - up to 4 digits. In addition,  $\epsilon_r$  measurement accuracy is independent from temperature and other factors. The moisture meter processor calculates the moisture content (W) based on the measured  $\epsilon_r$  value using calibration tables.

The moisture meter closest to **FIZEPR-SW100** among the known radiowave moisture meters in terms of its measurement method is made by **Phase Dynamics**. However, it is based on an absolutely different physical principle of resonance recording - by the minimum of reflected signal. The drawback of this approach is the time-consuming procedure of making a structure of the device for signal entry into the sensor cavity, so the instrument price is high. Refer to the diagram and drawings from **Phase Dynamics** patents given below.

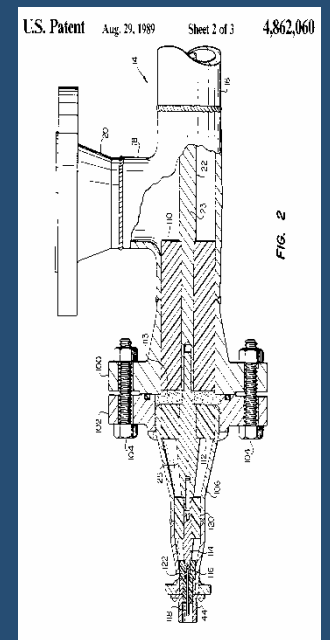
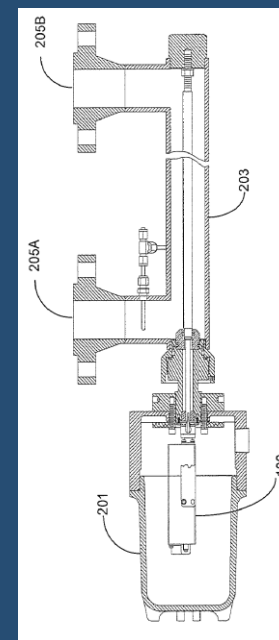
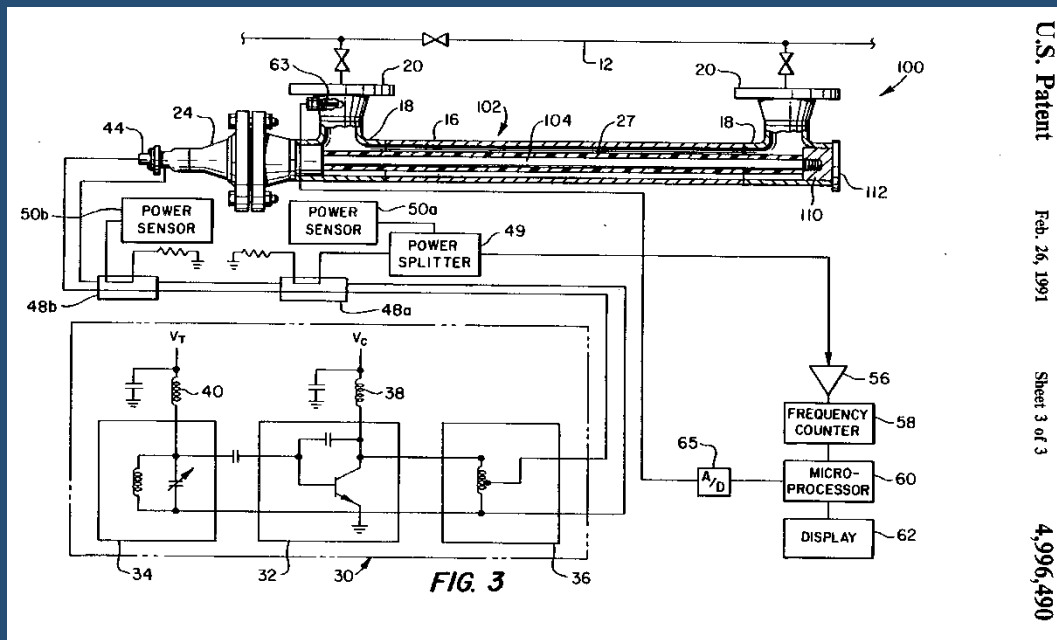

The basis for all **FIZEPR-SW100** series moisture meter is a new moisture measurement technology. The method developed by Design Bureau is protected by a number of Russian and foreign countries. Method features: (a) voltage is measured directly at the probe input, (b) the frequency spectrum of probe input voltage is analyzed in a wide range of frequencies to be the basis for resonance frequency determination.

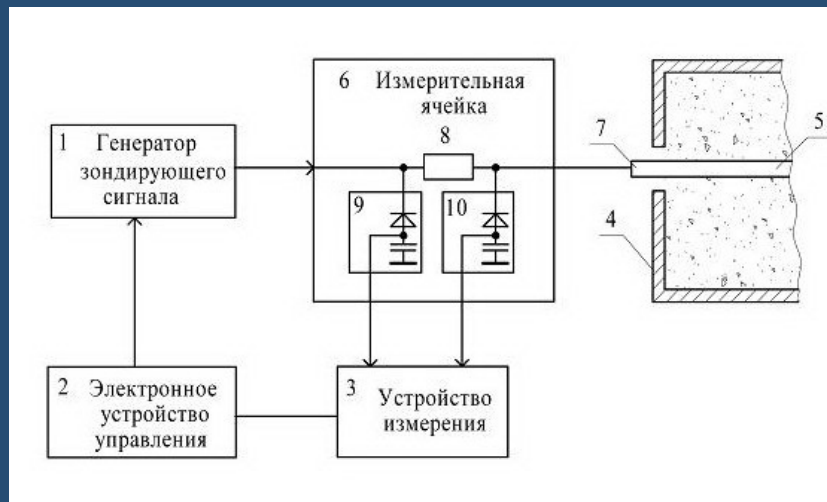

The moisture meter calculates the ratio of the resonant frequency of probe in air to its resonant frequency in a controlled material. Calculated ratio is equal to the controlled material refractive index ( $k$ ). Permittivity  $\epsilon_r$  is equal to:  $\epsilon_r = k^2$ .

This measuring method provides an absolute measurement of the material permittivity, without calibration using reference samples. This feature sets the FIZEPR-SW100 moisture meter apart from other ones.

The developed method determines the independence of measurement from the sensor probe length and version. The moisture meter calculates the water content based on calibration tables contained in its memory for each type of the test material. The proposed measurement method is implemented using simple design solutions thus providing a comparably lower cost of **FIZEPR-SW100** moisture meter manufacturing.

# Measuring media parameters at the temperature up to **+320°C**



The patented measurement method allows to locate sensor electronics far beyond the measured area.

The measurement area contains mechanical units and cables only that made of materials resistant to radiation and high temperatures.

This sensor can be used in systems periodically exposed to superheated steam exposure in the heat power industry to measure dryness fraction of steam as well as **in the nuclear industry**.

The high-temperature sensor ensures measurements of dielectric media parameters in the temperature range of **-20...+320°C** with the same high accuracy as mass produced sensors operating in the standard temperature range up to +145°C.



## Dependence on material temperature

The moisture meter processor calculates moisture depending on material temperature. The temperature is measured by a thermocouple inserted into the probe.

Temperature influence on the moisture value is shown in the graphs by the example of fuel oil M-100.

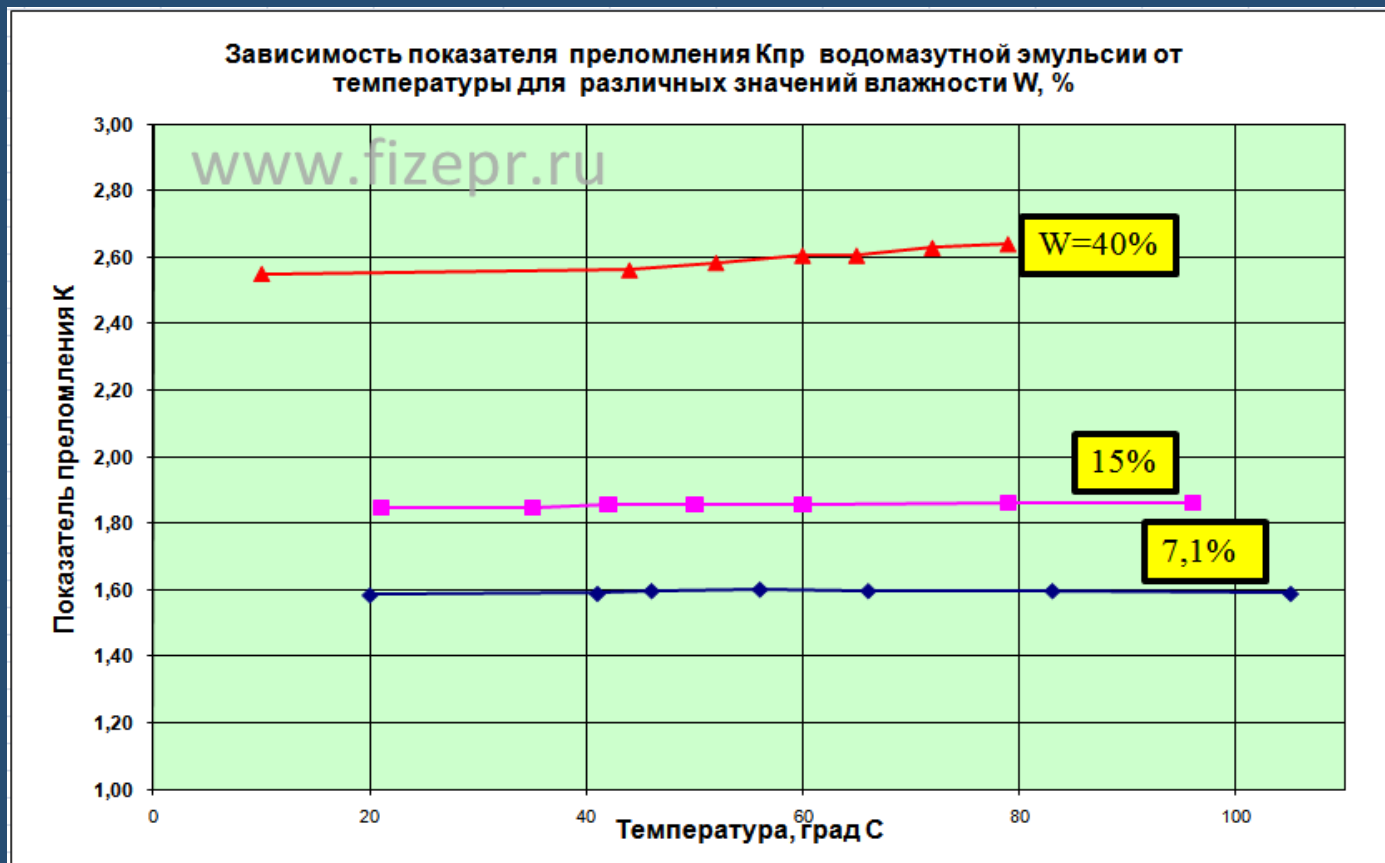

Important conclusion can be made from graphs: at low moisture of fuel oil its temperature can be ignored

**Design features of FIZEPR-SW100 moisture meters:  
electronics are separated from sensors and made as individual electronic units.**

Electronic units are supplied in the following versions:

- general purpose industrial version with sealed lead-ins;
- general purpose industrial version with bolt connectors;
- with certified 1ExdIIBT5, IP66 explosion-proof enclosure.



Due to electrical parameters all electronic units are interchangeable.

## Moisture meters FIZEPR-SW100.10.x for bulk materials

Moisture analyzers – moisture meters FIZEPR-SW100 VIGT.415210.100-10 are designed to measure the moisture of bulk materials in hoppers, dispensers and on conveyors.

Controlled materials: crushed stone, gravel, sand, ore, sawdust and wood chips, chemicals as well as mixed feed, grain, flour, seeds and other agricultural products.

The device consists of an electronic unit and a sensor.

Sensors are made in the following basic versions: with a flat-topped probe, with a straight rod probe and with a probe formed by two rods.



# Bulk material sensor designs

The probe is designed to be leak-proof. Stainless steel and heat-proof dielectric provides resistance to corrosion and the possibility of probe application in drying machines with temperatures up to +320 C.

Sensors are attached directly to the walls inside the hopper:

- 1) Sensor with a probe configured as a flat-topped bracket is mounted on the hopper wall via couplings;
- 2) Sensor with a probe made as a straight rod of 14-30mm diameter is fixed with its ends by holders-couplings on the opposite walls of the hopper.
- 3) Sensor with a two-pinned probe is secured in the hopper on the pipe G1 (1")

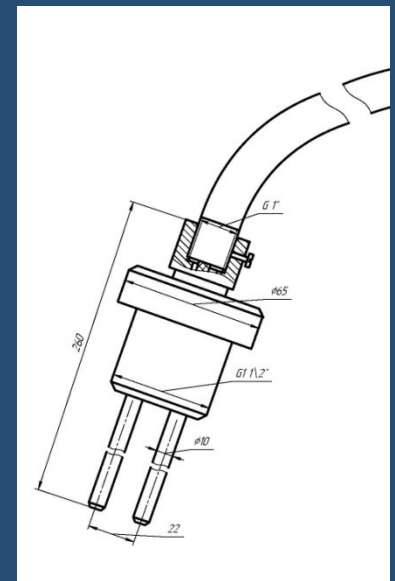
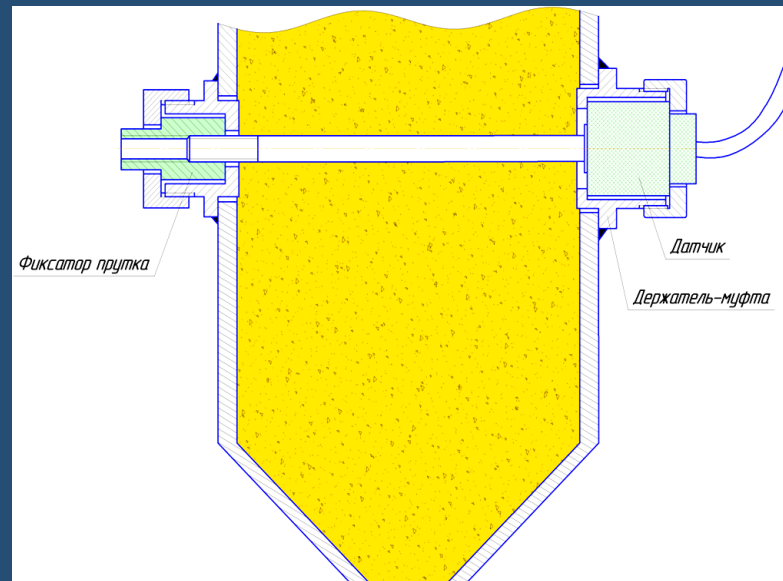
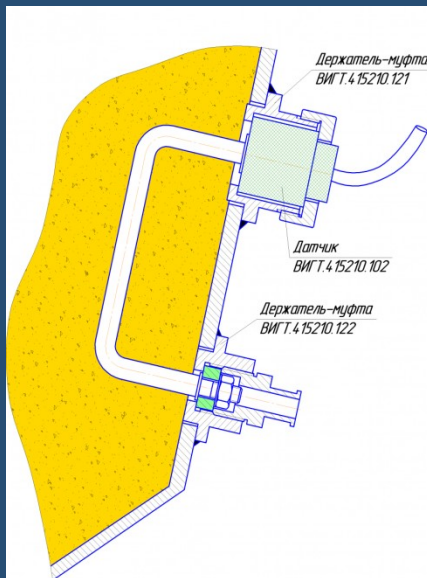



# Moisture meter FIZEPR-SW100.10 for bulk materials (with a flat-topped probe)

In the gravel hopper



On the  
dispenser



Easy-to-remove  
sensor



# Moisture meter FIZEPR-SW100.10.4 for bulk materials (with a straight probe across the hopper)





# Moisture meter FIZEPR-SW100.17 for concrete mixers



The front side of the sensor is protected with a plate of AISI 420 alloy - spring stainless steel highly resistant to abrasive wear. This sensor design is incomparably more resistant to front face impacts compared to ceramic plate sensors.

The sensor ensure concrete homogeneity and mobility during mixing. The sensor has no protruding elements and is designed for control inside the flow of abrasive materials, including high conductivity ones.

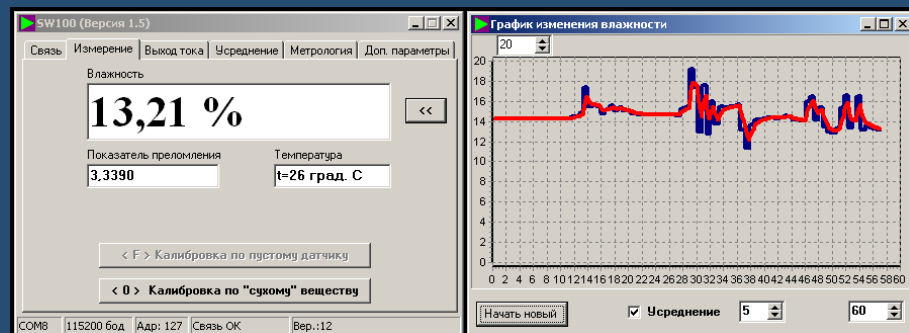

Due to its high sensitivity the sensor remains operational with an adhered concrete layer thickness up to 3-4 mm. It is operated on hard mixtures in Russian concrete mixtures of «SB-138» type.

# Laboratory moisture analyzer FIZEPR-SW100.30

The laboratory moisture meters – dielectric meters FIZEPR-SW100 VIGT.415210.100-30.1 and -30.2 have a high sensitivity and accuracy of measurements and provide measurement not only of moisture but also of the complex permittivity. They can be used both on liquid and bulk materials.

An analysis of the dielectric properties of material is provided by refractive index (deceleration factor) measurements of an electromagnetic wave in a controlled environment in the meter and decimeter wavelength ranges.

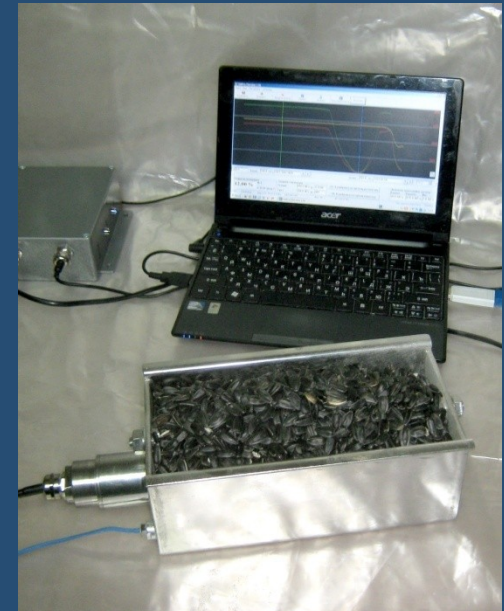



## Laboratory moisture meter FIZEPR-SW100.30.1 applications

- material composition studies in laboratories;
- operating control of material composition in production;
- control directly in fuel oil and petroleum tanks at different levels (sensor is equipped with a coupling for mounting on the pipe rod).

